

FIR-1/2/3/4/6  
LUX-1/2/3/4/6  
FS-2/3/6  
*Consumer manual*

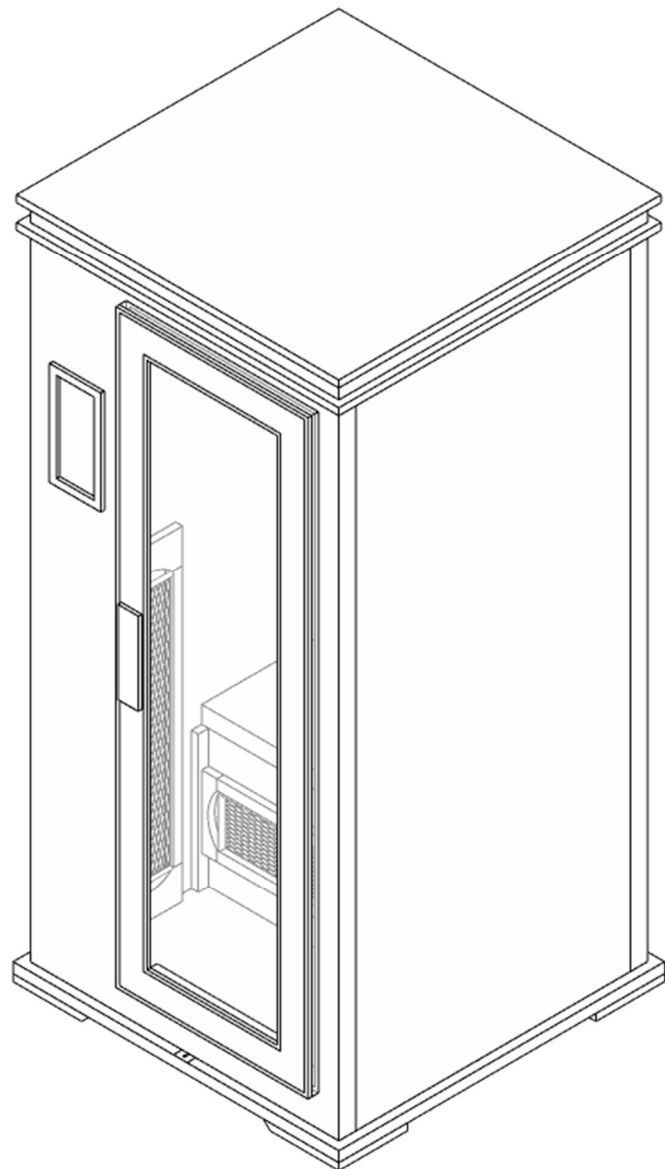

**Dear Customer,**

Thank you for purchasing a SaunaMed Sauna.

Before using your new sauna please read this consumer's manual carefully.

**Contents**

|                           |    |
|---------------------------|----|
| Preview                   | 3  |
| Operations                | 4  |
| Specifications            | 5  |
| Safety                    | 7  |
| Assembly and installation | 9  |
| Instructions for use      | 25 |
| Tips for use              | 34 |
| Troubleshooting guide     | 35 |
| Circuit diagram           | 39 |
| Warranty                  | 40 |



 **WARNING**

**DISCONNECT THE SAUNA FROM THE MAINS POWER SUPPLY BEFORE CHANGING ANY PARTS OR CARRYING OUT A SERVICE.**

*Preview*

All growth depends on sunlight. But 40% of the ultraviolet and the high energy rays of the sun are harmful to the human body; the remaining 60% of the sun's energy is beneficial, comprising infrared rays.

Our infrared sauna uses these invisible (5.6-15 $\mu$ m) infrared rays to increase cell tissue resonance, accelerate blood circulation and improve organic functions.

Infrared sauna therapy is becoming increasingly popular and accepted across the medical profession, with more studies now supporting the science behind this exciting new technology.

An infrared sauna can help relieve pain and improve wound healing and recovery by increasing blood circulation. The increased metabolic rate experienced in an infrared sauna actually burns calories as the body works to sweat. This aids fat burning, improves cardiac fitness, strengthens the heart, helps eliminate toxins and improves cellulite and general skin tone. A 30-minute session in an infrared sauna burns the same calories as a 10-kilometer run.

The quality stereo system fitted in our saunas aids relaxation with sound therapy and helps relieve stress.

## Operating conditions

|                             |                    |
|-----------------------------|--------------------|
| Operating temperature range | 5 - 40°C (ambient) |
| Humidity                    | ≤ 85%              |
| Pressure                    | 700 - 1060 hpa     |
| Power supply                | 220V - 240 V       |
| Frequency                   | 50 Hz              |
| EU Standard                 |                    |

Indoor use only: SaunaMed Saunas are primarily aimed at the domestic market.

Although a SaunaMed may be suitable for light commercial use, we do not recommend a SaunaMed for heavy commercial use, for example, public gyms, spas, and leisure centres.

Please contact us for information on site-specific suitability and commercial grade saunas.

**Do not install closer than 12.7mm (0.5 inches) to a wall.**

## Features

- Wooden construction
- Digital microprocessor controlled
- Temperature adjustable from 20°C – 60°C (5°C increments)
- Adjustable dwell time from 0 to 60 minutes
- Digital temperature sensor
- Soft touch keypad
- Long-life DuraWave™ EMR Neutral™ pure ceramic FAR infrared heaters

## Maintenance

- Clean the sauna room with a soft wet cloth or sauna cleanser. NEVER use alcohol, benzene or any other corrosive chemical to clean the unit.
- No maintenance or service of electronic components is required unless faulty. Please consult with the retailer or a qualified electrician if in doubt.

## Transportation and storage

- Avoid exposure to rain, snow, or other harsh environments during transport.
- When in transit, handle the sauna unit with care.
- Do not store in damp or humid environments.
- Ensure that the unit is installed on a level surface. Uneven surfaces may result in pooling and water ingress if the unit is installed in a bathroom; this can cause warping of the wooden floor module.
- If the surface on which the unit is installed is uneven and/or likely to be frequently exposed to moisture, place the unit on levelling supports to raise it above the floor.

Specifications

**Dimensions**

| Model   | Dimensions (mm)    | Plans and elevations (same plan for FIR and LUX) |  |
|---|--------------------|--|--|
| FIR-001 / LUX-001<br>(1-person<br>Classic/Luxury) | 900 x 900 x 1900   |  |  |
| FIR-002 / LUX-002<br>(2-person<br>Classic/Luxury) | 1200 x 1000 x 1900 |  |  |
| FIR-003 / LUX-003<br>(3-person<br>Classic/Luxury) | 1500 x 1200 x 1900 |  |  |

Specifications

**Dimensions**

| Model   | Dimensions (mm)    | Plans and elevations (same plan for FIR and LUX) |        |
|---|--------------------|--|--------|
| FIR-004 / LUX-004<br>(4-person<br>Classic/Luxury) | 1800 x 1200 x 1900 |  |        |
|   |                    | FIR-4  | LUX -4 |
| FIR-006 / LUX-006<br>(6-person<br>Classic/Luxury) | 1500 x 1500 x 1900 |  |        |
|   |                    | FIR-6  | LUX -6 |

**Specifications**

**Dimensions**

| Model                              | Dimensions (mm)                   | Plans and elevations (same plan for FIR and LUX) |
|------------------------------------|-----------------------------------|--|
| FS-002<br>(3-person Full Spectrum) | 1100 x 900 x 1900<br>(w x d x h)  |  |
| FS-003<br>(3-person Full Spectrum) | 1400 x 1250 x 1900<br>(w x d x h) |  |
| FS-006<br>(6-person Full Spectrum) | 1800 x 1500 x 1900<br>(w x d x h) |  |

## General Safety Rules

- All wiring to the sauna heater and accessories must be routed away from any direct radiation from the sauna heater.
- DO NOT place receptacles, flammables, and combustibles inside the sauna unit.
- DO NOT spray water or any other liquids onto the interior or exterior surfaces of the sauna unit.
- DO NOT install any plumbing fixtures (such as taps, showers, steam generators etc.) in the sauna unit.
- DO NOT install any locking and/or latching system on the door, as the malfunction of these parts can cause entrapment inside the sauna.
- If located in a bathroom, ensure that the bathroom is well ventilated.

SaunaMed sauna units are only suitable for zone 3 or above (see diagram below). Installing a sauna in a wet location with insufficient ventilation can result in electrical faults and

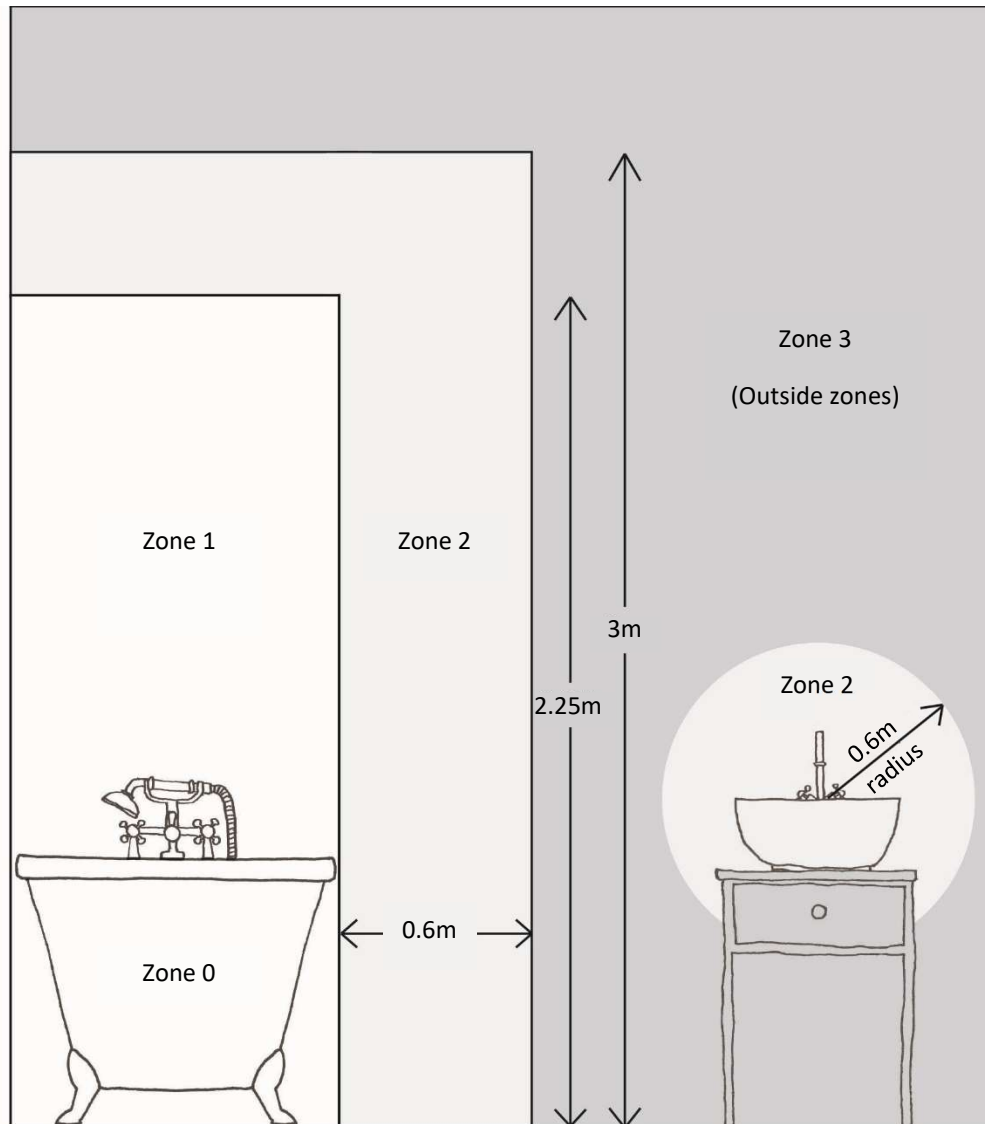



## Safety Precautions

- DO NOT dry clothes or leave towels in the sauna.
- DO NOT touch the heating elements with bare hands or metal tools.
- DO NOT touch the light when it is on.
- DO NOT enter the sauna when wet.
- DO NOT use the sauna if you have or suffer from any of the following conditions:
  - Open wounds or serious burns
  - Eye conditions
  - Heat sensitivity
  - Obesity
  - Heart disease
  - High and/or blood pressure
  - Circulatory system problem
  - Diabetes
- DO NOT use the sauna if you are, or think you may be, pregnant.
- DO NOT place pets in the sauna.
- DO NOT use the sauna after drinking excessive alcohol.
- This appliance is not intended for use by persons (including children) with reduced physical, sensory, or mental capabilities, or lack of experience and knowledge, unless they have been given supervision or instruction concerning use of the appliance by a person responsible for their safety.
- Children should be supervised to ensure that they do not play with the appliances.
- Be careful when using the appliance in places where there are combustible materials.
- DO NOT use in an explosive atmosphere.
- Be aware that heat may be conducted to combustible materials that are out of sight.
- DO NOT leave the appliance unattended when it is switched on.

IF THE POWER SUPPLY CABLE IS DAMAGED, IT MUST BE REPLACED BY A QUALIFIED ELECTRICIAN OR AS A COMPLETE ASSEMBLY AVAILABLE FROM THE MANUFACTURER OR ITS SERVICE AGENT.

### Pre-assembly checklist

- Items required for installation

1 x screwdriver  
(included)

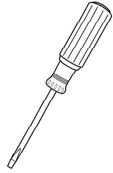

1 x spacer for wall  
alignment (included)

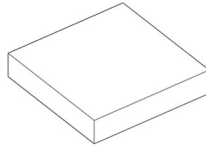

1 x base panel

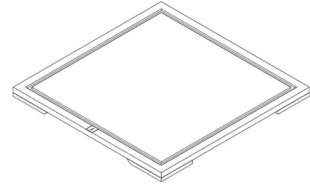

1 x front panel



1 x back panel



1 x LHS panel  
(2 x LHS panels for FIR/LUX 6)



1 x RHS panel  
(2 x RHS panels for FIR/LUX 6)



1 x door handle



1 x set of screws for  
installing the door handle



2 x bench units  
(4 x bench units for FIR/LUX 4/6)

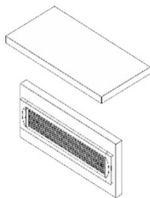

Roof panel

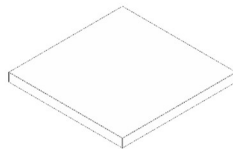

30 to 60mins assembly  
time



## Pre-assembly notes

- Two Persons are recommended for safe assembly.
- Please pay attention to the following before installation.
- Position the sauna on a flat and level surface.
- DO NOT splash the exterior with water. If the floor is damp, install a floor separator to keep the sauna dry.
- DO NOT store any flammable objects or chemical substances near the sauna.
- *The example shown in these instructions is the model FIR-001 (1-person Classic). Other models vary in design but the procedure remains the same. For diagrams of the 4 and 4-6 person models, please refer to the following 2 pages.*

### Using the spacer

- To connect the wall sections together easily, use the wooden spacer (refer to images below) to bring the 'male' and 'female' connector pins into alignment.
- When connecting the side panels to the back panel, ensure that one assembler holds the back panel in place while the other assembler places the spacer on the edge of the floor section before placing the side wall on top of the spacer. This will raise the height of the male pins in the side wall to the same height as the female pins in the back without the need for lifting.
- Once the pins are pushed together and secure, remove the spacer from under the wall section. The wall panel will drop and lock into place.
- Check that both the top and bottom pins are fully connected before moving onto the next section.

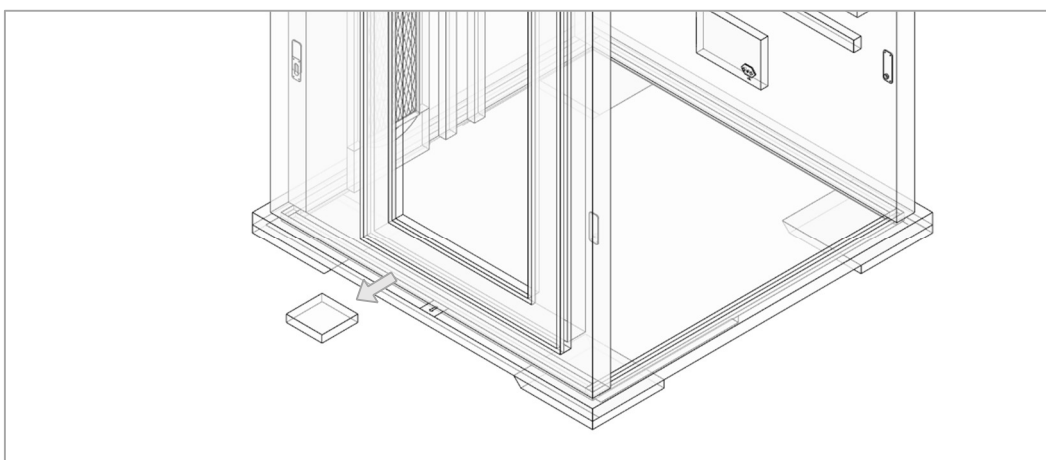
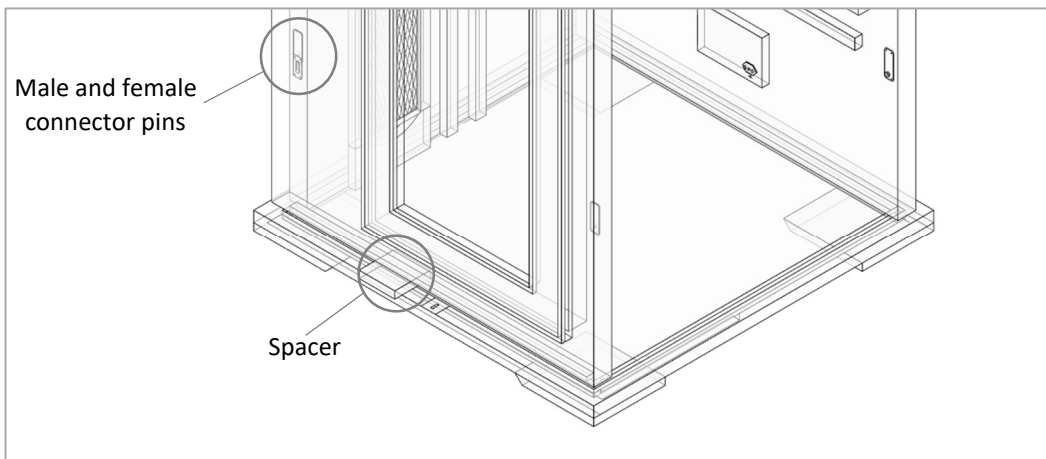

### Assembly sequence for 4-person saunas

- There are 2 benches for the 4-person / 4 – 6 person sauna models. Horizontal bench guides are located on the front and back panel; these will indicate the position of the 2 benches.
- When installing the benches, slide the bench modules all the way in until it touches the side panels on three sides and is securely in place.
- Please install the front panel prior to installing the bench heaters on all 4-person models.

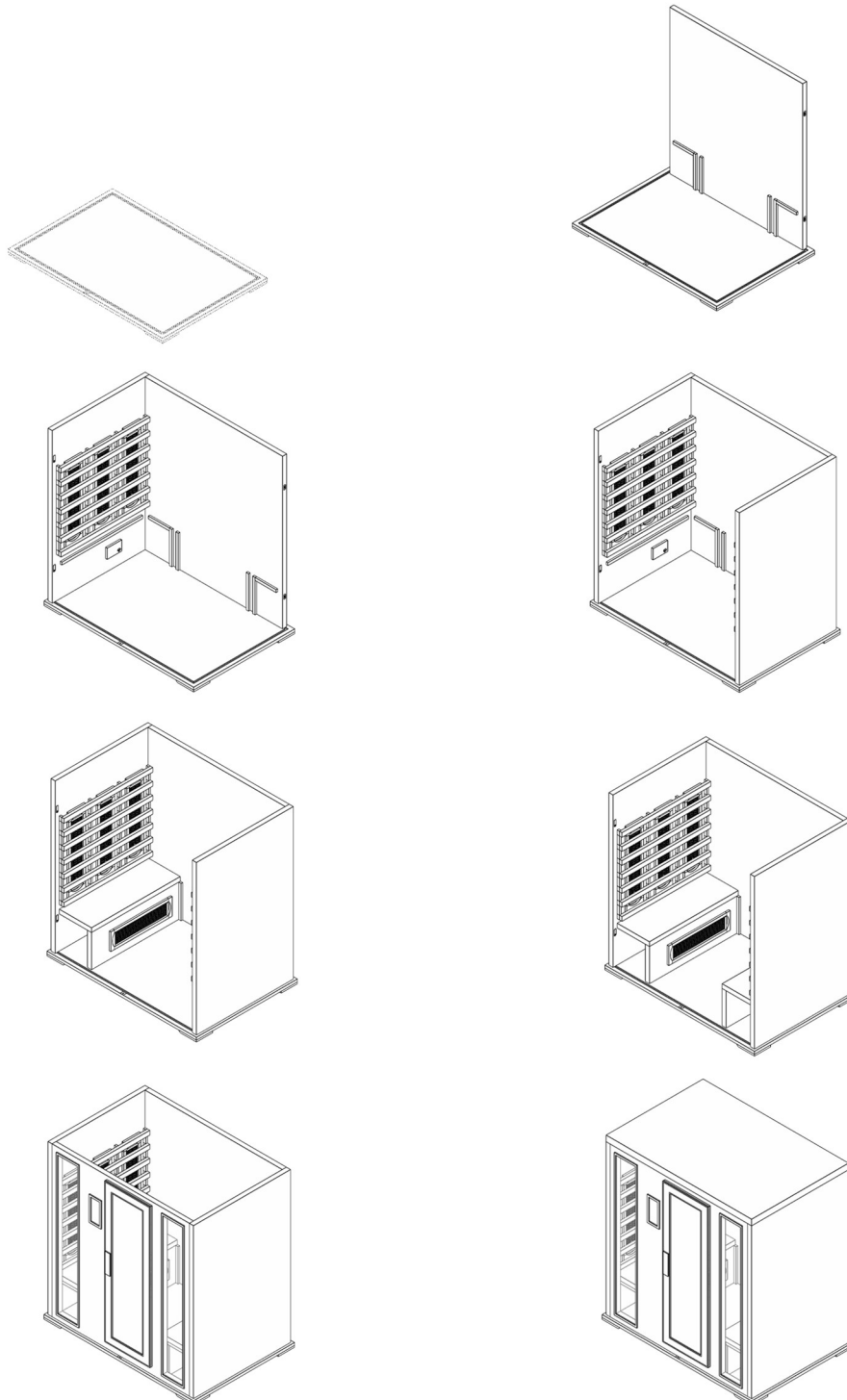

### Assembly sequence for 4 – 6 person saunas

- Please install the benches before installing the front section when assembling 4 – 6 person saunas.

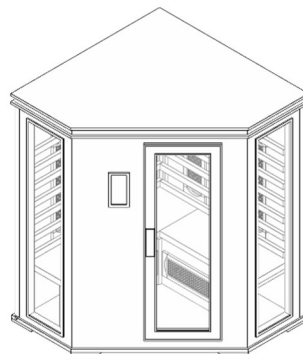
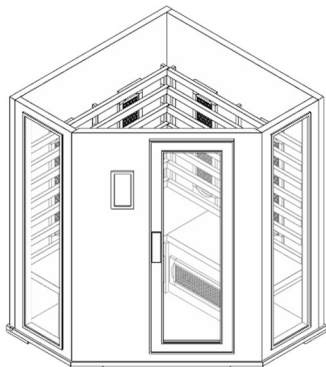
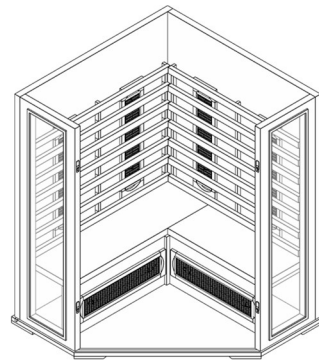
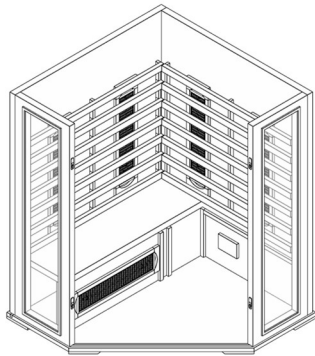
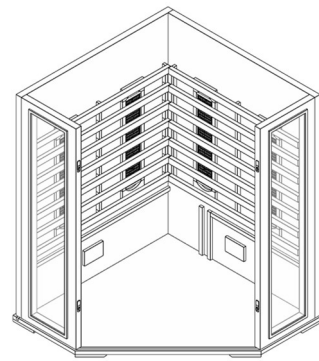
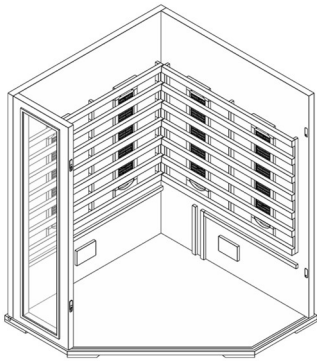
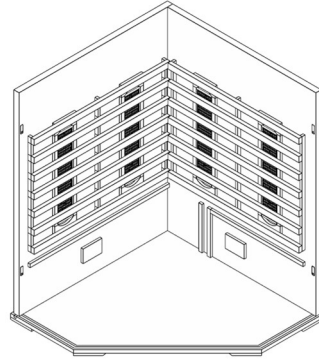
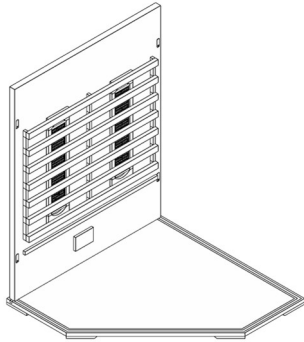

## **Assembly process**

### Step 1

Position the base section in the location where sauna is to be installed (please obey safety distances).

Ensure the 'Front arrow' sticker is facing up and is to the front

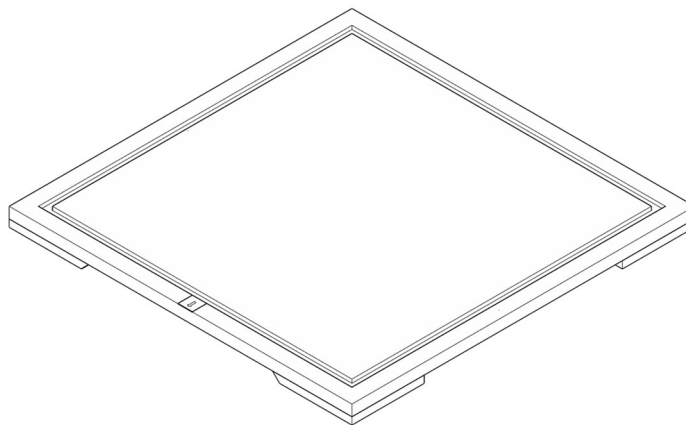

## Assembly process

### Step 2

Position the rear panel with pre-installed back rest at the back of the base section.

Please note that during the Assembly Process, for the Full Spectrum Models (FS Models) the Panels of the cabin go AROUND the base, like shown in the example to the Right. This is for steps 2 - 6.

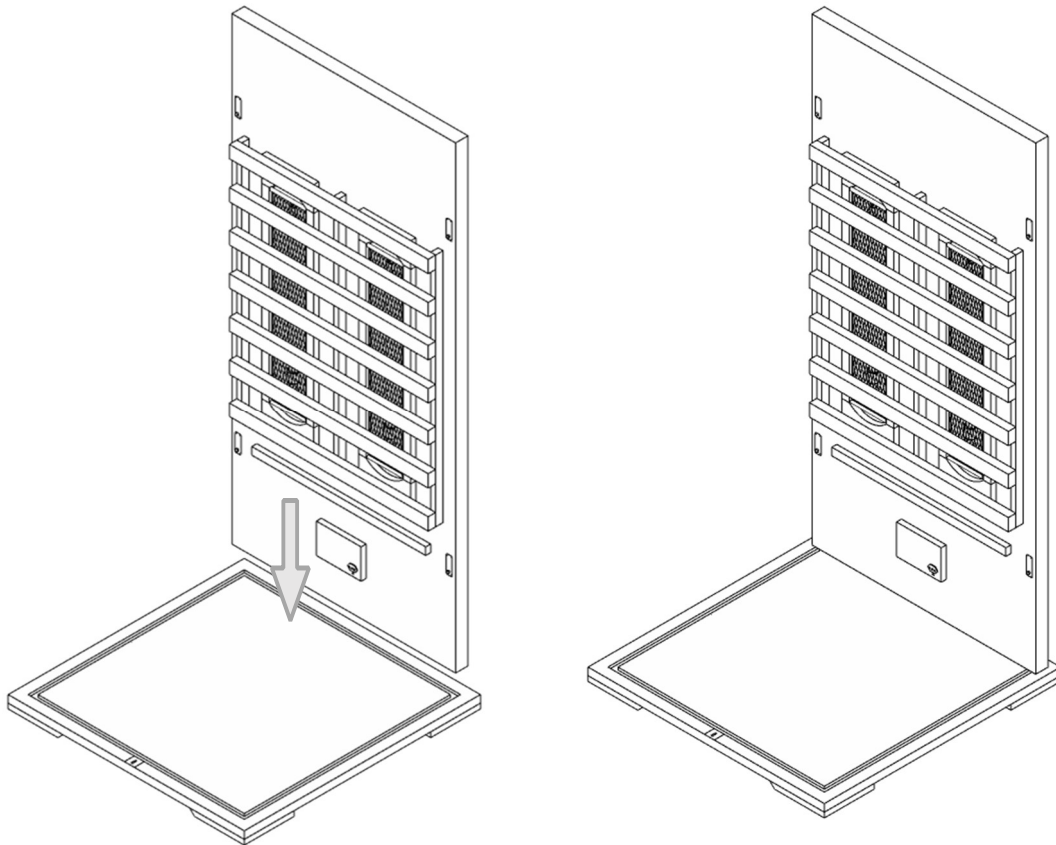
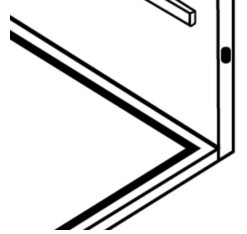



### Assembly process

#### Step 3

Install left hand side panel.

Ensure that hidden internal connectors are aligned. The panel then drops down to lock in place.

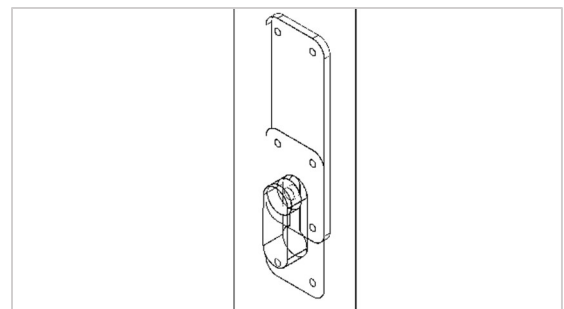
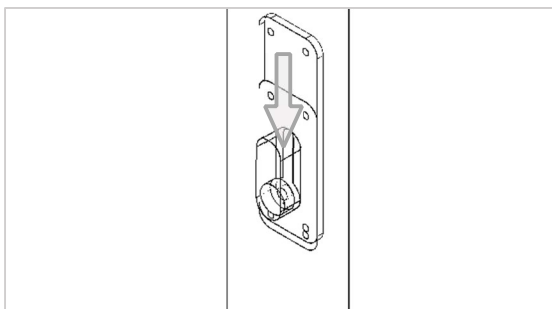
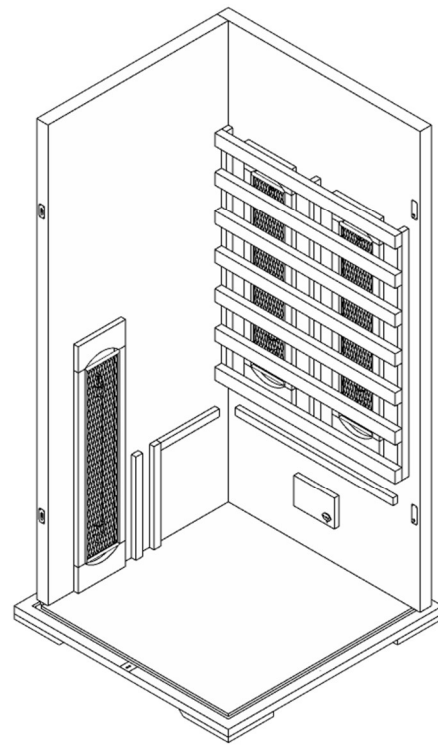
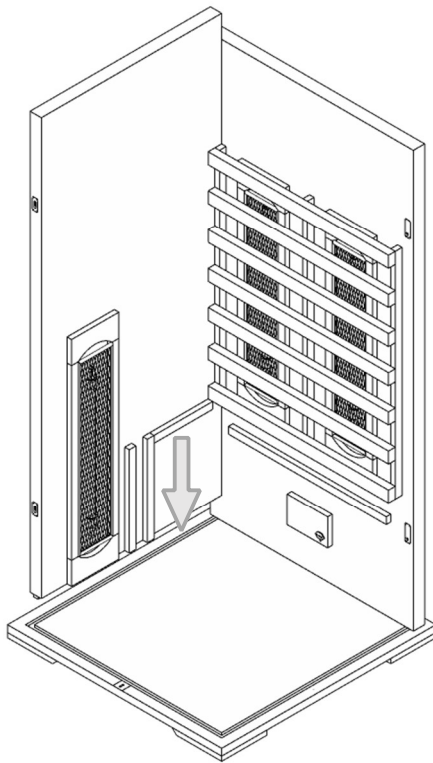

**Assembly process**

Step 4

Install the right hand side panel.

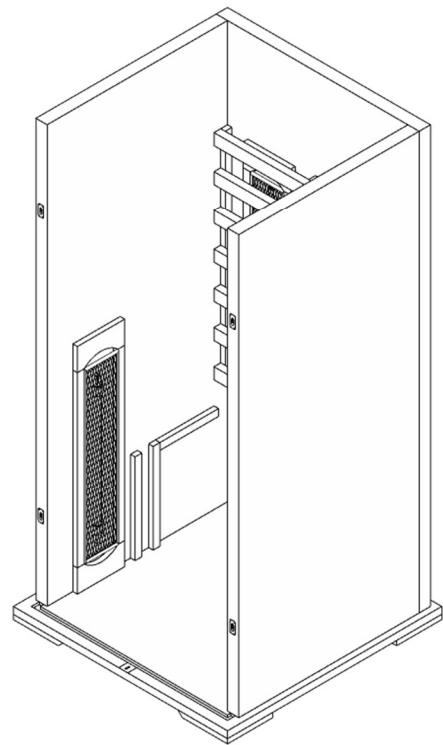
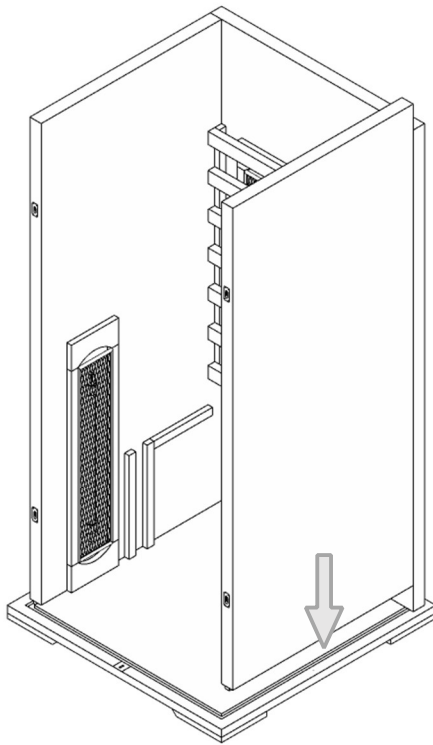

### Assembly process

#### Step 5

Install the under bench heater and bench panel as shown in the images below.

Ensure that the heater connections are secure.

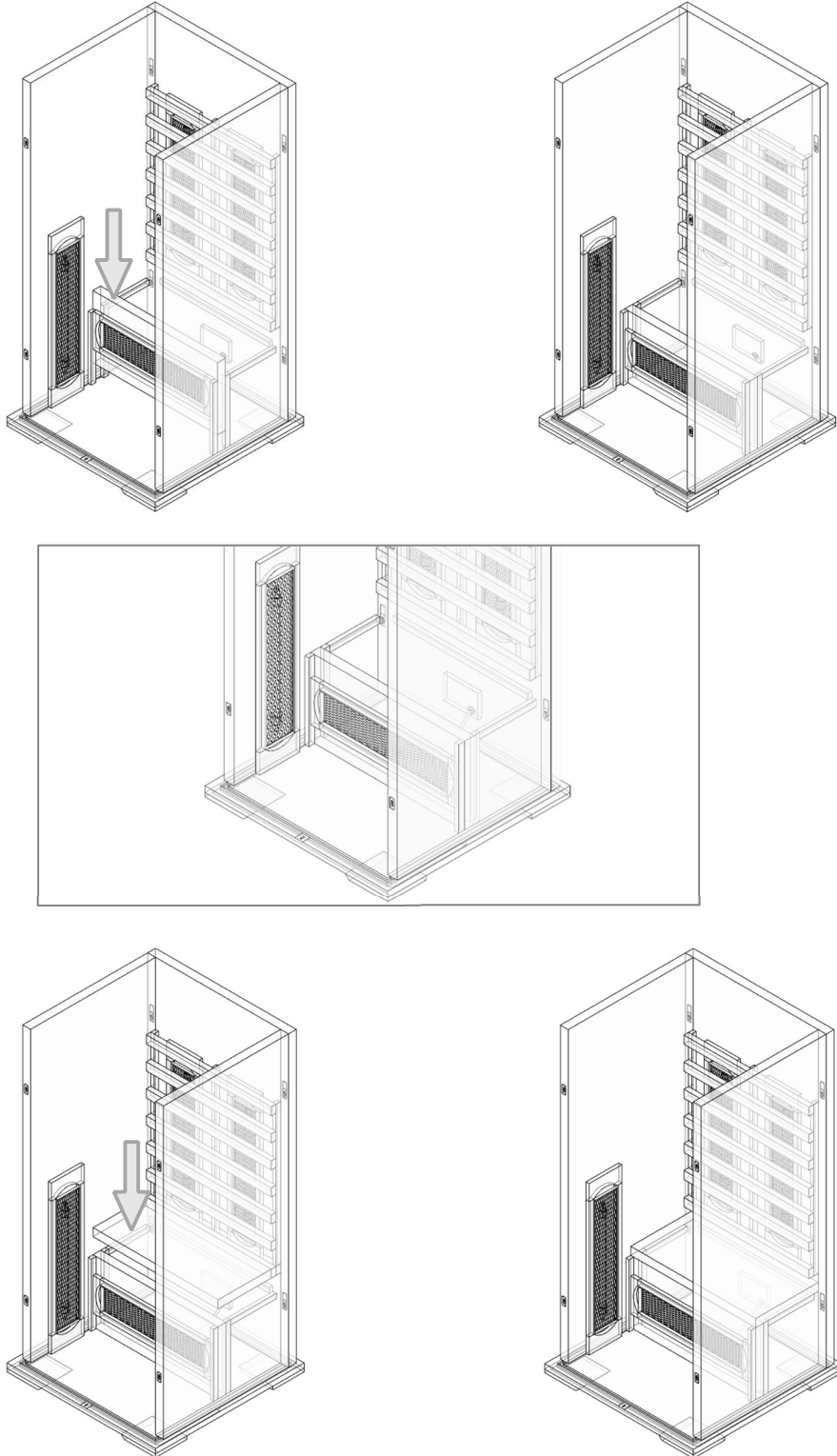

## Assembly process

### Step 6

Install front sauna panel with pre hung door making sure that all panels are sat flush with the sauna base.

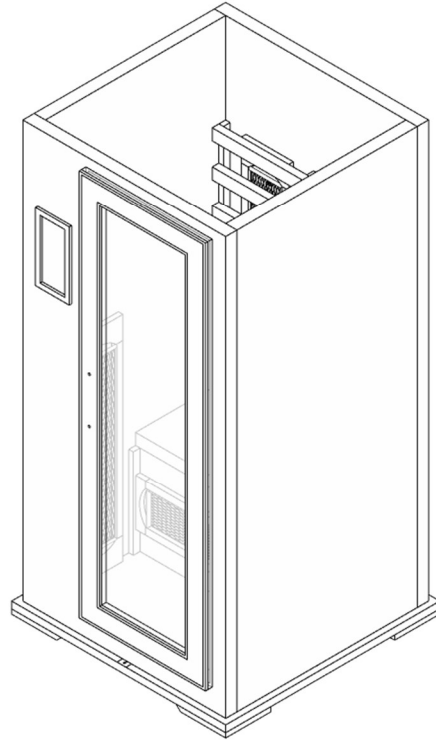
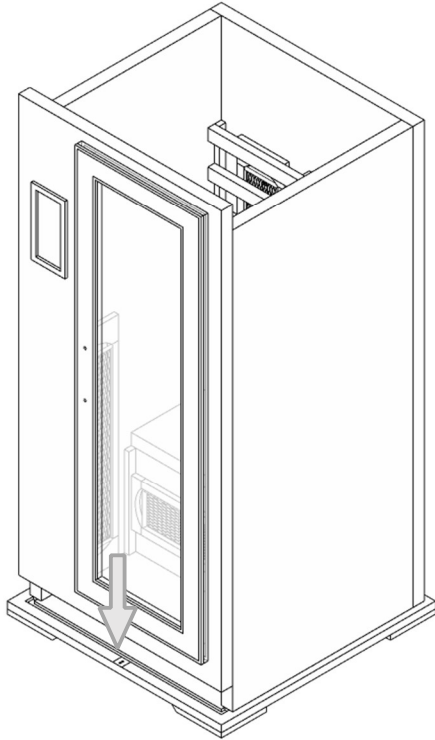

## Assembly process

### Step 7

Install the door handle using the 2 screws and screwdriver provided.

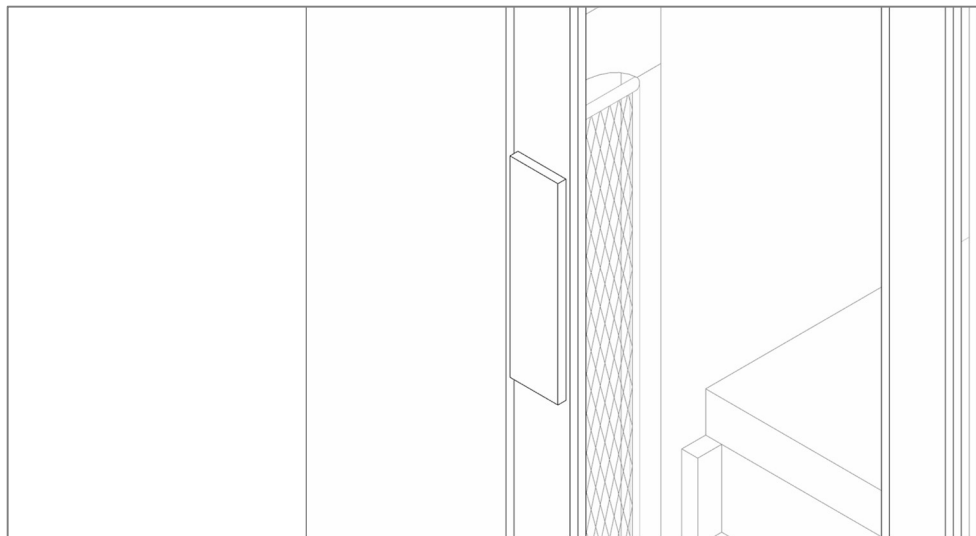
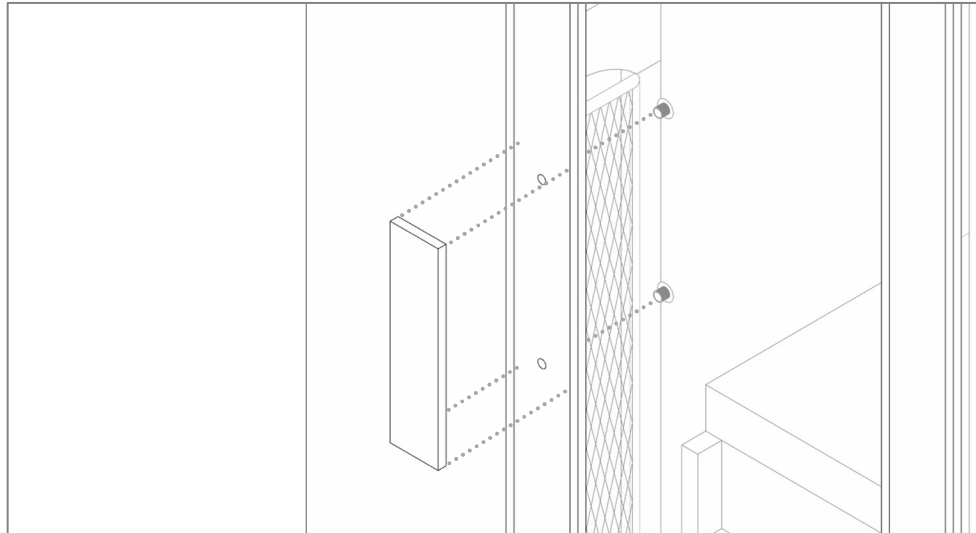

## Assembly process

Step 8

2 persons are needed for this step.

Attach the roof panel to the sauna taking care to ensure that all the cables have been fed through the pre-drilled holes.

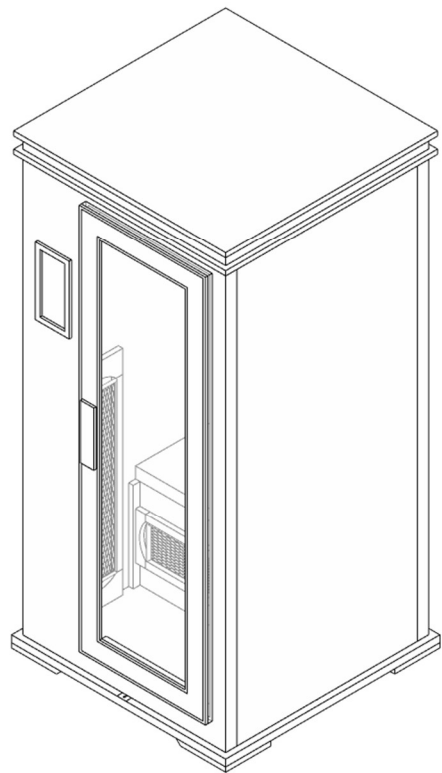
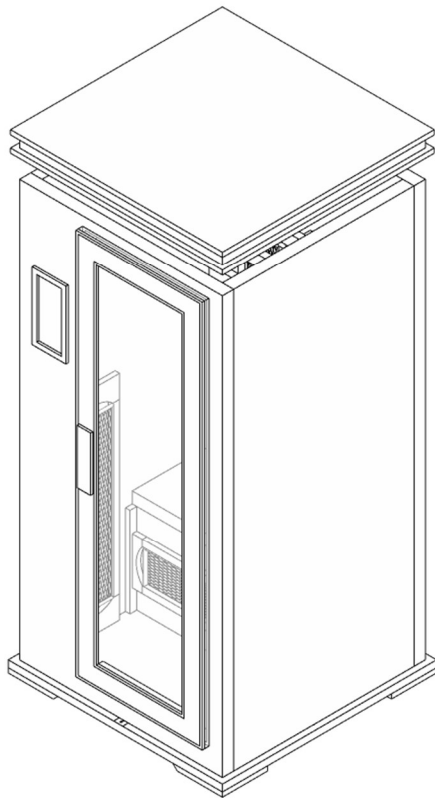

### Assembly process

#### Step 9

Complete all the necessary connections on the roof of the sauna, making sure that the cables are firmly connected.

Please make sure that when connecting the ribbon cables you push the connectors together until you hear a 'click'.

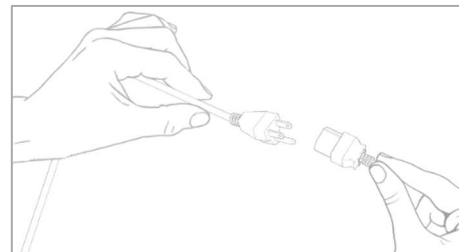
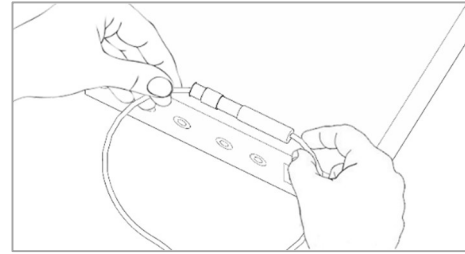
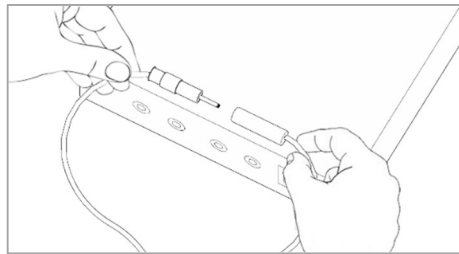
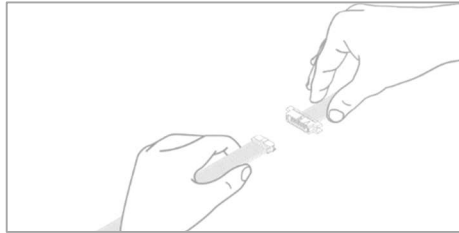

## **Assembly process**

### Step 10

Once you have verified that the sauna is working correctly, install the 3 cover panels on the sauna roof panel. The middle panel must have the holes to the rear of the sauna over the internal vent. These can be secured with the screws provided.

Take care not to over tighten the screws.



*Instructions for use*

**Temperature Sensor**

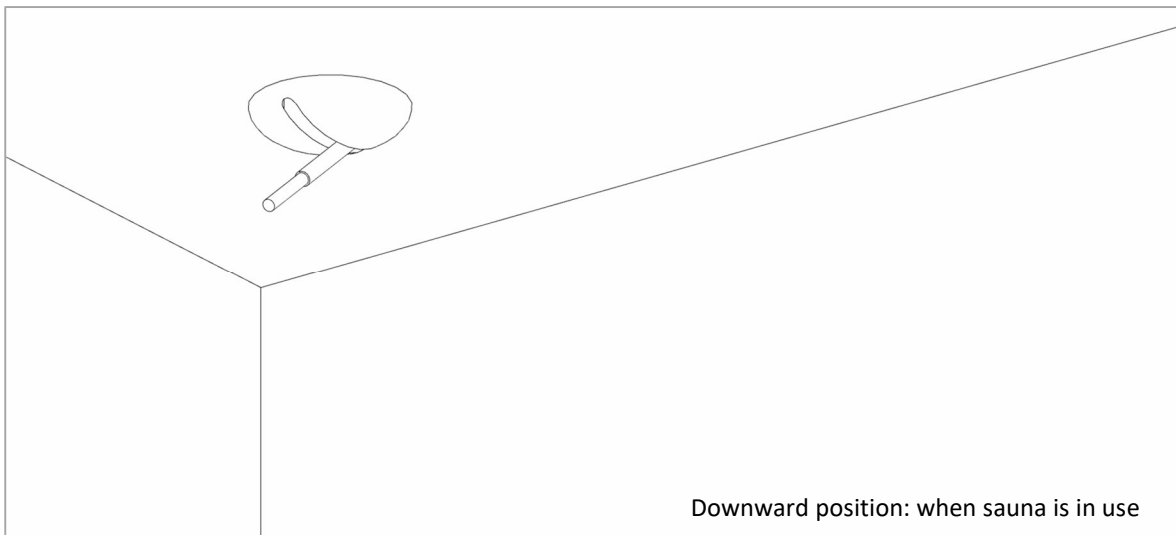
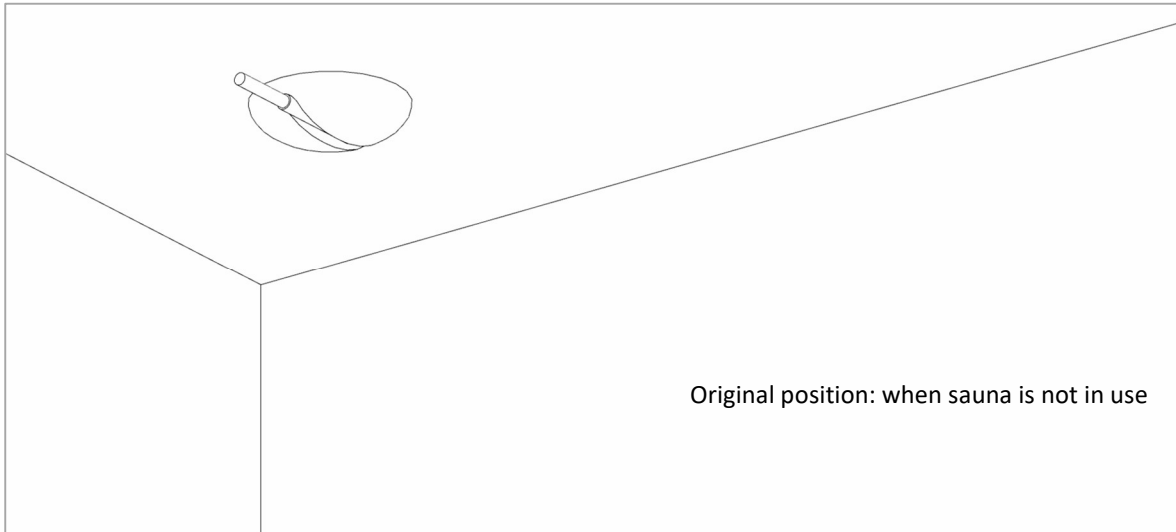

When sauna is in use, point the temperature sensor vertical downward, as shown in the figure below, to ensure the accuracy of the temperature display on the control panel.





### Control Panel

1. Connect the sauna to the mains power supply.
2. Press the  key. The power LED will illuminate.
3. The temperature will display the current temperature inside the sauna.



### Adjusting the temperature

Press the  or  keys under the temperature display to adjust the temperature. It changes in 10°F or 5°C increments for each press. The set temperature will blink for 15 seconds before returning to the current temperature.

Press the  and  together to toggle between Fahrenheit or Celsius mode.

The highest temperature that can be set is 140°F or 60°C.

### Adjusting the heating duration

Press the  or  keys under the Time & EQ Display to adjust the time. It changes in 5-minute increments for each press.

The minimum and maximum heating duration is 5 minutes and 60 minutes respectively.

The heaters will automatically switch off after the set duration has elapsed.

### Turning the light on/off

Press the  key to turn the internal cabin light on or off.

Pressing the  key will turn on the external light on the model FIR-006 (6-person classic sauna) only. This feature is not available on other 'Classic' saunas.

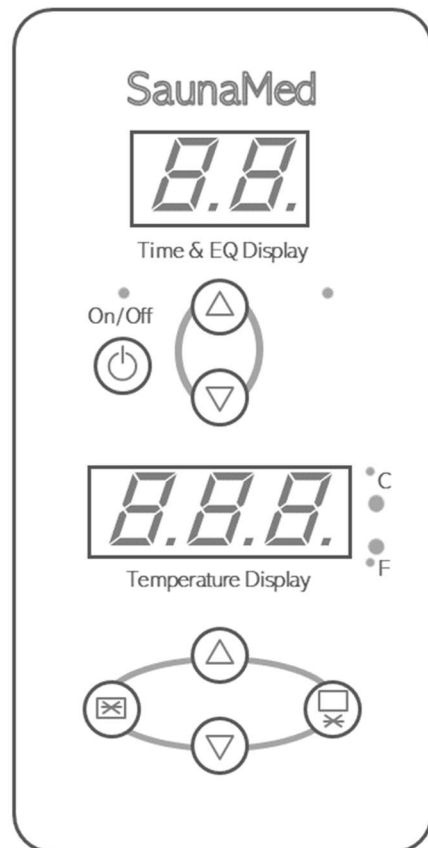



## Operating the media panel

### Adjusting the FM radio station

Press the  button to select FM mode.



Press the  button to switch the FM radio on.

Press the  or  keys to finetune the FM frequency.

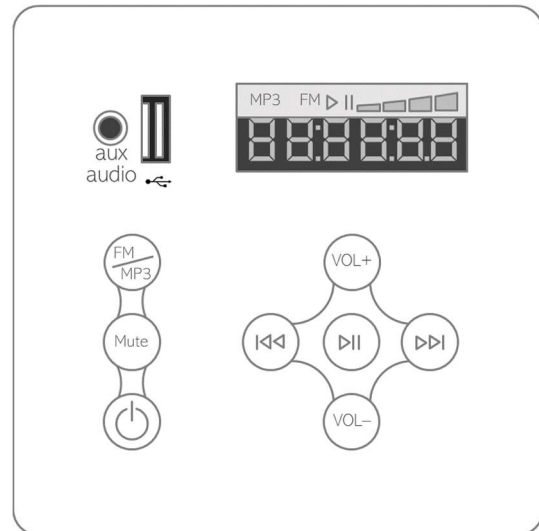
Press and hold the  or  key to scroll through the various FM radio stations.





### Adjust the volume



Press the  and  buttons to increase and decrease the audio volume as required.



### Playing music via the USB port

Ensure that all tracks on the USB memory stick are in .mp3 format.

Insert the USB memory stick into the USB port .

Press the  button to select MP3 mode.

Tracks will begin playing automatically if the  button is already on play mode. Otherwise, press the  button to begin playback.

Use the  or  button to skip selected tracks. A short press will scroll to the previous/next track. A long press will rewind/fast forward until the button is released.

### Play music via and MP3 player/iPod

Select FM mode using the  button.

Insert one end of the provided cables into the aux audio port  on the media panel and the other to the headphone output on the MP3 player/iPod.

Press the  button to select playback.

Use the playback and volume controls on the MP3 player/iPod as normal.

## Operating the colour light therapy unit

When powered on, the integrated light therapy unit will circulate from White, Red, Green, Blue, Yellow, Purple, Cyan, and Orange.

Press and the light will stop on the next colour in the sequence.

Press and hold to turn the unit off.

On the remote control, press to turn the unit on or off.

Press PR to pause the colour cycle or stay on a certain colour.

You can also manually select the light colour by using the colour choice buttons.

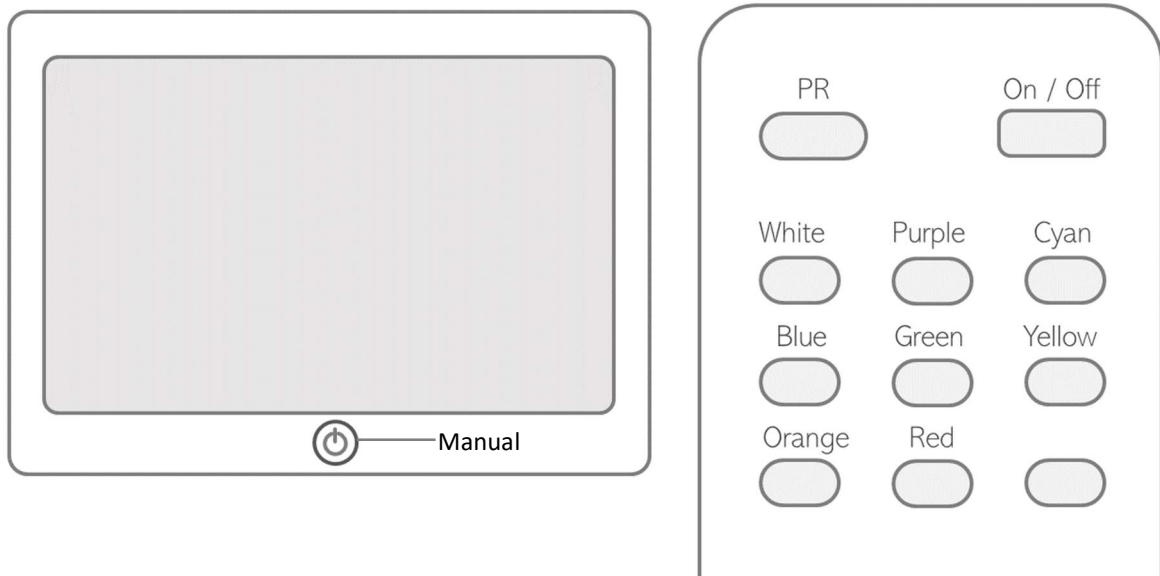

## *Tips for use*

Set the temperature to a comfortable level. This is normally around 40 to 60C/104 to 122 F.

Allow approximately 8 – 15 minutes for the sauna to warm up.

Perspiration will begin with 6 to 15 minutes after stepping into the unit. We recommend a sauna session of no longer than 45 minutes.

When the temperature reaches the level set on the thermostat, the heaters will turn off and on periodically to maintain the desired temperature level inside the sauna.

The front door/window/ceiling vent can be opened at any time to allow fresh air into the sauna.

Drink plenty of water before, during, and after each session to replenish lost fluids.

Taking a hot shower or bath before the sauna session will accelerate perspiration. However, do dry off thoroughly before entering the sauna cabin, as excessive water will stain and/or warp the wood.

To absorb perspiration and to keep the sauna tidy, place a towel on the bench and floor of the sauna. Keep one towel handy to wipe sweat from the body.

Massage any affected areas to relieve sore and tense muscles.

Shaving your face or legs with a razor while profusely sweating during a sauna session yields an incredibly smooth skin without the use of gels or foams.

Do NOT eat at least one hour before a sauna session. It is recommended to enter the sauna with an empty stomach.

Do NOT use the sauna immediately after strenuous exercise.

At the first sign of a cold or flu, increasing the frequency of sauna sessions may be beneficial in boosting your immune system and decreasing the proliferation rate of viruses.

Any area you wish to expose to deep heating should be moved closer to the heaters.



After the sauna session is over, do not leave the cabin immediately. Allow the body to perspire for about 2 minutes. Then, take a warm shower and finish off with a cold shower to cool off completely.

Consult your physician for the proper treatment or any other conditions.

Open the ceiling vent to allow for ventilation if required.

Follow the sequence of solutions presented in the order that they appear. Should you encounter any further issues and/or if you do not feel confident to carry out checks or repairs on your own, consult a qualified electrician.

Power and electrical configurations

| No. | Observation  | Diagnosis  | Solution  |
|-----|--|--|---|
| 1   | The entire sauna does not power up.                    | This is most likely an issue with the 12V transformer.   | <p>Check the main switch and both fuses and ensure they are connected properly.</p> <hr/> <p>Check the fuses and ensure they are in full working order.</p>   |
| 2   | The power indicator does not light up.                 | <p>The fuse is blown or the sauna is not plugged in.</p> <hr/> <p>The connection to the control panel is faulty.</p> <hr/> <p>The PSU (power supply unit) is faulty.</p> | <p>Change the fuse or check the plug.</p> <hr/> <p>Check the ribbon cable and connectors to ensure that they are connected properly.</p> <hr/> <p>Replace the PSU.</p>  |
| 3   | The soft keys on the control panel are not responsive. | The connection to the control panel is faulty.   | <p>Check the ribbon cable and connectors to ensure that they are connected properly.</p><br><p>Unplug the sauna from the power socket. Wait for 1 minute and reconnect the sauna to the power socket.</p>   |
| 4   | The circuit breaker constantly trips.                  | The protective coating on the wires may be causing an earth leakage.   | <p>Allow the sauna to warm up from the power supply without the circuit breaker.</p><br><p>This evaporates the protective coatings, after which the sauna will operate normally.</p>  |
| 6   | The sauna switches itself on.                          | The delay start time has accidentally been activated.  | <p>Check that the delay start timer has not been activated. If the LED light on the RHS of the control panel under the 'Time &amp; EQ' display is on, the delay start timer has been activated.</p> <p>Press the  and  keys together to turn the delay start timer off.</p> |

Infrared heaters

| No. | Observation                                     | Diagnosis  | Solution   |
|-----|---|--|--|
| 1   | One or several of the heaters does not heat up. | The wiring to the heater is faulty.                                  | Check the ribbon cable and connectors to ensure that they are connected properly.  |
|     |   | The heating element(s) is /are defective.                            | Replace the heating element(s) and dispose of the faulty ones safely.<br><br>Replacement heating elements can be ordered from Aqualine Saunas UK.  |
|     |   | One of the relay switches is faulty.                                 | Check the power board on the top of the sauna cabin in the metal box. You will find two relay switches. One may be faulty and you can request for a replacement relay board. However please consult a qualified electrician if in doubt. |
|     |   |  |  |
| 2   | None of the heaters are heating up.             | The sauna is not connected to a power source.                        | Check the ribbon cable and connectors to ensure that they are connected properly.<br><br>Unplug the sauna from the power socket. Wait for 1 minute and reconnect the sauna to the power socket.  |
|     |   | The control panel is faulty.   | Replace the control panel.   |
|     |   | The relay board is faulty.   | Replace the relay board.   |
| 3   | The heater under the bench does not heat up.    | The heater is not connected tightly to the outlet on the back panel. | Check the connection between the heater and the power outlet, and ensure that it is secure.  |
|     |   | The heater is faulty.  | Replace the heater.  |

Control panel

| No. | Observation   | Diagnosis  | Solution   |
|-----|---|--|--|
| 1   | The control panel works, but none of the heaters work.  | The set heating duration has elapsed.  | Check that the control panel has not timed out.  |
|     |   | The relay board is not connected properly.   | Check the relay board and ensure that all connections are in place.  |
|     |   | The heaters' connection pins in the Printed Circuit Board (PCB) are incorrect.     | Ensure that the connection pins between the control panel and PCB are connected properly (you can check this by opening the CD box).   |
|     |   | The sensor is not properly connected to the PCB.                                   | Ensure that the sensor is properly connected to the PCB.   |
|     |   | The set temperature is lower than the ambient temperature outside the sauna cabin. | Check the set temperature and ensure that it is higher than the ambient temperature outside the sauna cabin. The heaters will not function if the set temperature is lower than the ambient temperature. |
|     |   | The heat sensor is faulty.   | Replace the heat sensor.   |
| 2   | The control panel does not power up but the radio works.  | The circuit box is not properly connected to the control panel.                    | Check the connector that connects the circuit box to the control panel and ensure that it is connected properly.   |
| 3   | The control panel does not work (new sauna, and assuming there is a working power supply to the sauna). | The ribbon connectors are not firmly connected.                                    | Check the ribbon connector is connected firmly. There should be a 'click' noise when you fasten the ribbon cables together, indicating they are securely fastened together.                              |



Other equipment and paraphernalia

| No. | Observation  | Diagnosis  | Solution  |
|-----|--|--|---|
| 1   | The CD player works but the radio does not work.             | The aerial connection cable is not connected properly.   | Check the aerial connection cable and ensure that it is connected properly.                                       |
|     |  | The radio is faulty.   | Replace the radio.  |
| 2   | The radio works but the CD player does not work (new sauna). | The clamping screws on top of the sauna are preventing the sauna from functioning properly.                | Check the clamping screws on the top of the sauna cabin. These must be removed before the sauna is ready for use. |
| 3   | The temperature sensor does not work.                        | The temperature sensor is faulty.  | Replace the temperature sensor.   |
|     |  | The control panel is faulty.   | Replace the control panel.  |
| 4   | The sauna does not power up but the radio works.             | It is likely that the transformer is in working condition and that it is the control panel that is faulty. | Double-check that the transformer is in working order. If the control panel is faulty, replace it promptly.       |
| 5   | The temperature deviates +/- 3°C from the set temperature.   | This is normal and a built-in feature to extend the life of the relay switch.                              | No action needed.   |

Circuit diagram

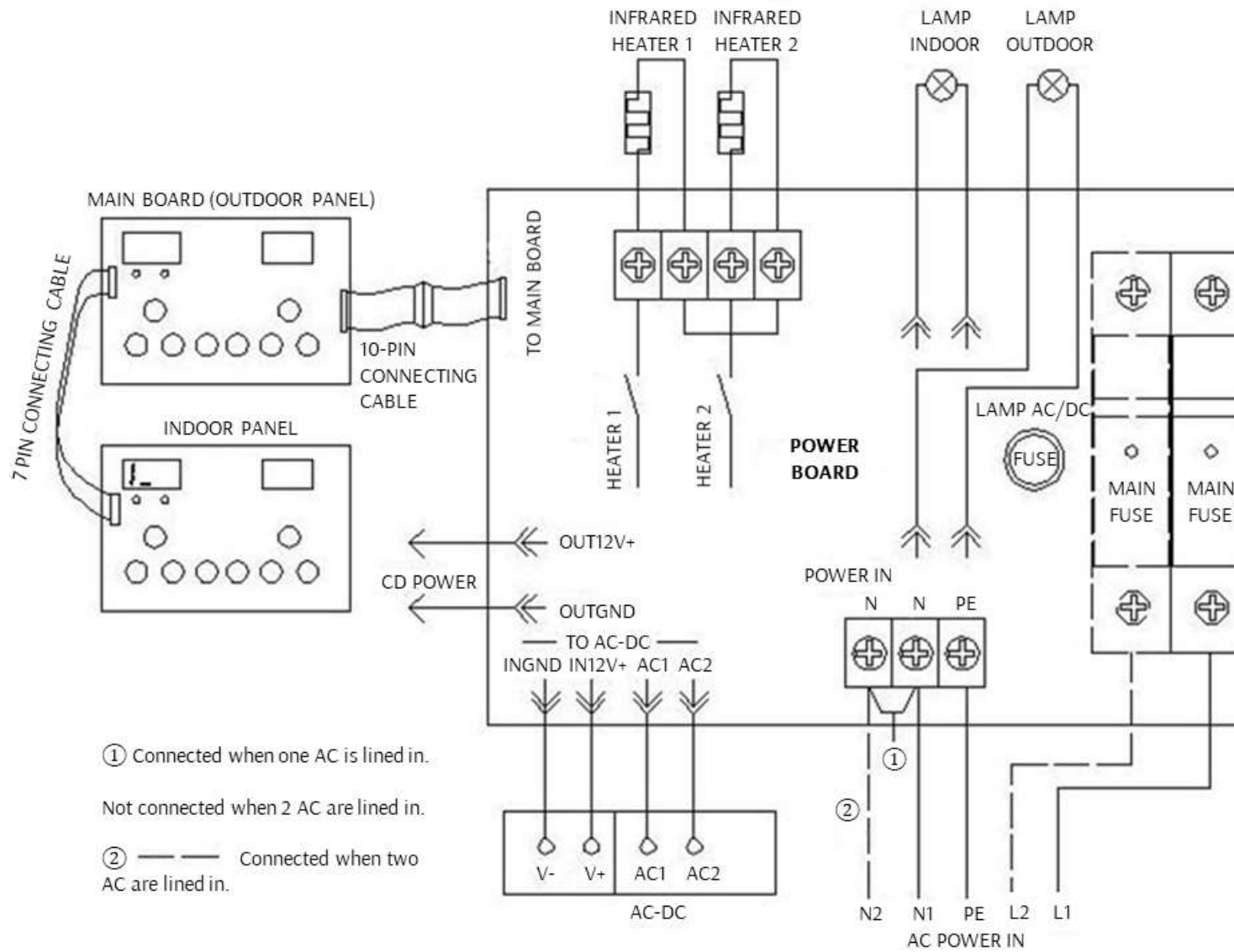

## Warranty

SaunaMed warrants that the sauna will be free from defects in materials and workmanship for a period of two (2) years for the electronic components and five (5) years for the cabin from the date of purchase.

If the product proves defective during the warranty period, SaunaMed, at its discretion, will:

1. repair the product by means of telephone or email support or depot service at no charge for parts, OR
2. replace the product with a comparable product which may be new or refurbished, OR
3. refund the amount paid for the product, with a reasonable allowance for usage, upon its return.

SaunaMed recommends the customer first utilizes support materials shipped with the product, the troubleshooting guide (see Pages 35 - 38), information found on the Aqualine website, and email support.

If unsuccessful, to obtain service under this warranty, the customer must notify SaunaMed Telephone Support or its authorized service representative of the defect before the expiration of the warranty period. Customers are to provide appropriate assistance to telephone support personnel to resolve issues.

If telephone support is unsuccessful, SaunaMed or its authorized service representative will instruct the customer on how to receive warranty repair.

In the maintenance of the product, SaunaMed may use new or equivalent to new parts, assemblies, or products for equal or improved quality. All defective parts, assemblies, and products become the property of SaunaMed. SaunaMed may require the return of parts, assemblies, and products to a designated to the SaunaMed representative from which the part, assembly, or product was originally purchased. Return and claims will be handled according to the current SaunaMed procedure.

These warranties shall not apply to any defect, failure or damage caused by improper use or improper or inadequate maintenance and care.

SaunaMed shall not be obligated under these warranties:

- a. to repair damage resulting from attempts by personnel other than SaunaMed representatives to install, repair, or service the product unless directed by a SaunaMed representative,
- b. to repair damage, malfunction, or degradation of performance resulting from improper use or connection to incompatible equipment,
- c. to repair any damage, malfunction, or degradation of performance cause by the use of non SaunaMed supplies or consumables or the use of SaunaMed supplies not specified for use with this product,
- d. to repair an item that has been modified or integrated with other products when the effect of such modification or integration increases the time or difficulty of servicing the product or degrades performance or reliability,
- e. to perform user maintenance or cleaning or to repair damage, malfunction, or degradation of performance resulting from failure to perform user maintenance and cleaning as prescribed in published product materials,
- f. to repair damage, malfunction, or degradation of performance resulting from use of the product in an environment not meeting the operating specification set forth in the user manual,

Warranty

- g. to repair damage, malfunction, or degradation of performance resulting from use of the product in an environment not meeting the operating specification set forth in the user manual,
- h. to warranty repair this product after it exceeds the print volume referenced in this warranty statement,
- i. to replace items that have been abused, misused, or tampered with in any way,
- j. to install replacement items that are considered customer replaceable,
- k. to provide control panel software or firmware upgrades or upgrades.

Any service identified in the above list and provided by SaunaMed at the customer’s request shall be invoiced to the customer at SaunaMed’s then current rates for parts, labour, and travel.

**THE ABOVE WARRANTIES ARE GIVEN BY SAUNAMED WITH RESPECT TO THIS PRODUCT AND ITS RELATED ITEMS IN LIEU OF ANY OTHER WARRANTIES, EXPRESS OR IMPLIED, SAUNAMED, AND ITS VENDORS DISCLAIM ANY IMPLIED WARRANTIES OF MERCHANTABILITY OR FITNESS FOR A PARTICULAR PURPOSE OR ANY SIMILAR STANDARD IMPOSED BY APPLICABLE LEGISLATION. SAUNAMED’S RESPONSIBILITY TO REPAIR, REPLACE, OR OFFER A REFUND FOR DEFECTIVE PRODUCTS AND RELATED ITEMS IS THE SOLE AND EXCLUSIVE REMEDY PROVIDED TO THE CUSTOMER FOR BREACH OF THESE WARRANTIES.**

Some states, provinces, and countries do not allow the exclusion or limitation of incidental or consequential damages or exclusions or limitations on the duration of implied warranties or conditions, so the above limitations or exclusion may not apply to you. This warranty gives you specified legal rights, and you may also have other rights that vary by state, province, or country.

**TO THE EXTENT ALLOWED BY LOCAL LAW, EXCEPT FOR THE OBLIGATIONS SPECIFICALLY SET FORTH IN THIS WARRANTY STATEMENT, IN NO EVENT SHALL SAUNAMED AND ITS VENDORS BE LIABLE FOR ANY INDIRECT, SPECIAL, INCIDENTAL, OR CONSEQUENTIAL DAMAGES (INCLUDING LOSS OF PROFITS) WHETHER BASED ON CONTRACT, TORT, OR ANY OTHER LEGAL THEORY AND IRRESPECTIVE OF WHETHER SAUNAMED OR THE VENDOR HAS ADVANCE NOTICE OF THE POSSIBILITY OF SUCH DAMAGES.**

---

Date of purchase

---

Date of delivery

---

Model number

---

Serial number (printed on the inside of the back panel)

---

Dealer information (name and contact number)

---